











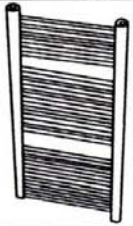

Premier Towel Rail

Fitting Instructions









Assembly Instructions for Ladder Rail

Contents List

Ref	Description	Quantity
A	 Ladder Rail	1
B	 Blanking Plug	1
C	 Air Vent Plug	1
D	 Wall Support	4
E	 Masonry Wall Plug	4
F	 Long Screw	4
G	 Small Screw	4
H	 Spacer	4
I	 End Cap	4
J	 Cross Bolt	4
K	 Bracket Bush	8

Tools Required (not supplied)

Description
 PTFE Tape
 Large Flat Screwdriver
 8mm Masonry Bit or 3mm Wood Bit
 Socket Set
 Spanner
 Clean Cloth
 6mm Allen Key



Bathroom Taps & Showers
Bathroom Furniture
Heated Towel Rails

Tel: 0845 22 55 045

cs@smrBathrooms.co.uk

Designer Radiators
Radiator Valves
Cast Iron Radiators

Fax: 0845 22 55 046



- 5 Mounting to Brick or Breezeblock**
 At the required fixing positions drill hole using 8mm masonry bit and insert the wall plug **E** into the hole ensuring it's flush with the wall. Place long screw **F** through the centre of the wall support **D** and tighten into the wall plug.

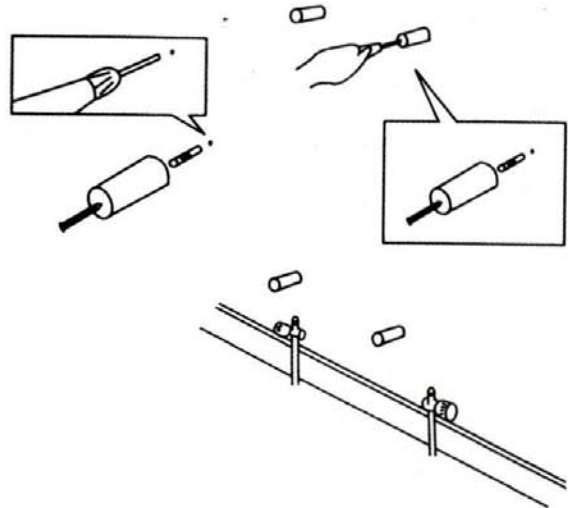

Mounting to Wood
 Place long screw **F** through the centre of the wall support **D** and screw into the wooden baton at the required fixing positions.

- 6 Place the spacer **H** inside the wall support and insert the small screw **G** into the hole in the wall support. Don't over-tighten to allow for adjustment later.**

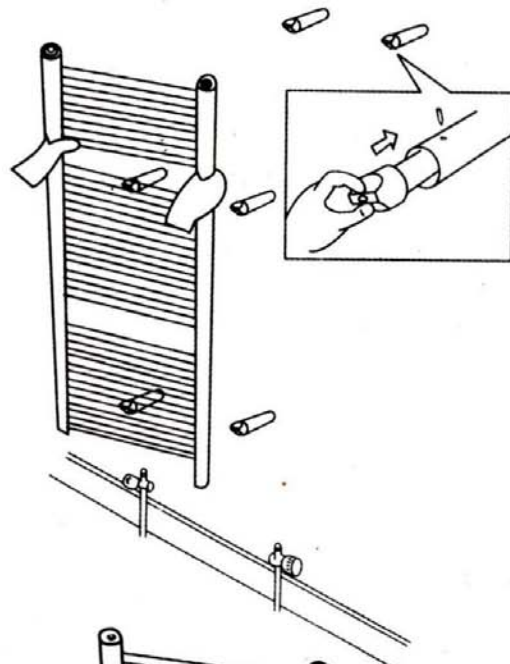

- 7 Offer the ladder rail **A** up to the fixing brackets and place bolt **J** through the bracket bush **K**.**



Place the bolt between the selected ladder rail bars and thread into the wall support ensuring the square face of the bracket bush is aligned with the ladder rail.

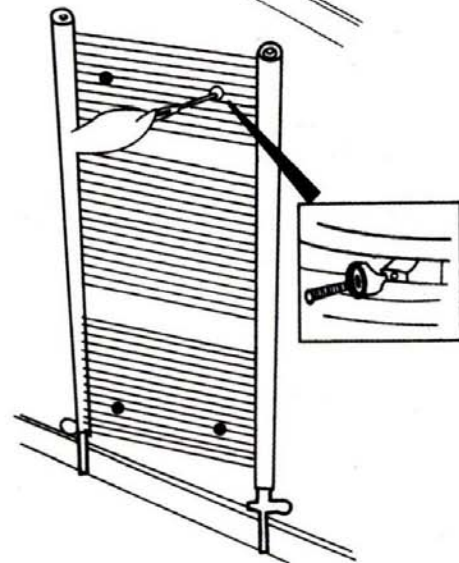

Bathroom Taps & Showers
 Bathroom Furniture
 Heated Towel Rails

Tel: 0845 22 55 045

cs@smrBathrooms.co.uk

Designer Radiators
 Radiator Valves
 Cast Iron Radiators

Fax: 0845 22 55 046



- 8 Push the rail flat against the wall, adjust to required depth and tighten the small screws to secure. Push the end caps I over each of the bracket heads until they click into position.

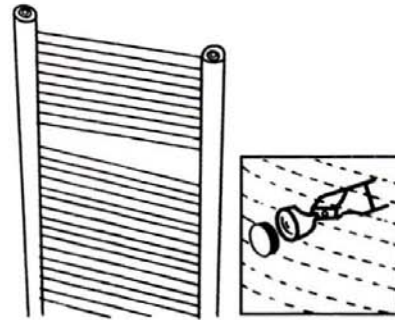

- 9 Connect the radiator valve tail to the radiator valve and tighten securely. Apply PTEE tape.

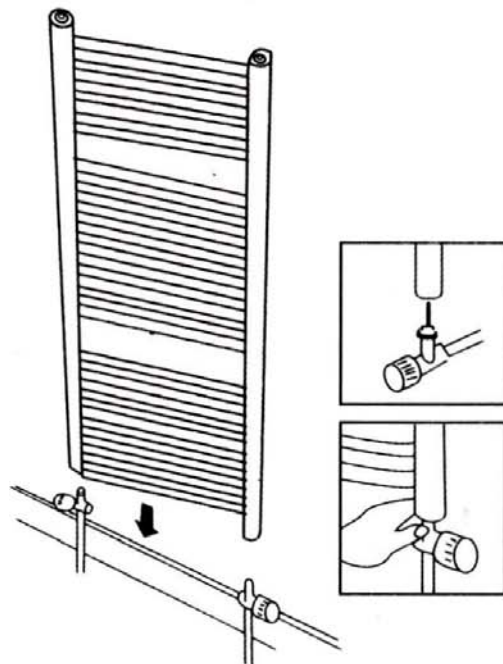
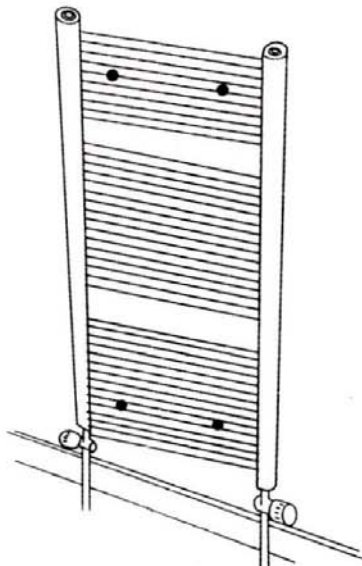

Important

- Ensure that your central heating system is thoroughly flushed before use to rinse out any foreign residues.
- Wipe the surface clean with a soft, damp cloth. Never use abrasive cleaners on this product as they will damage the surface.
- It is recommended that a suitable inhibitor be added to the central heating system to help prevent internal corrosion and limescale build-up.



Bathroom Taps & Showers
Bathroom Furniture
Heated Towel Rails

Tel: 0845 22 55 045

cs@smrBathrooms.co.uk

Designer Radiators
Radiator Valves
Cast Iron Radiators

Fax: 0845 22 55 046

